

SPECIFICATION FOR APPROVAL

產品確認書/製品仕様書

FILE SERIAL NO./檔序號:	XSG20230721002-T01
CUSTOMER / 客戶:	
ARTICLE / 品名:	SWITCHING POWER SUPPLY
MODEL NO. / 機種型號:	XSG2406250
PARAMETER / 規格:	24.0V6.25A
CERTIFICATE/認證:	AA,RCM,CE,CB,PSE,GS,UL,cUL,ETL,FCC,LVD,EMC,UKCA,KI
ISSUE DATE / 發行日期:	2023/7/21

Please to sign back after you confirm

承認書確認後請回簽一份

この仕様書をご確認とご署名の上、対象の営業窓口にご返信いただきますよう宜しくお願い致します。

CUSTOMER AUTHORIZED 客戶確認		
Approved by	Checked by	Prepared by

SUPPLIER AUTHORIZED 供方確認		
Approved by	Checked by	Prepared by
李麗敏	賀子豐	張文娟

*感謝您的支持，我們十分珍惜每次合作機會

*Thank you for your support,we will treasure the opportunity to cooperate with you

Rev.版本	Description of change/ 變更內容描述		Changed Date 日期	Approved
	Before(變更前)	After/變更後		
A	Original Release(初次發行)		2023/7/21	李麗敏



* Make practical and safe power supply, Be enterprise with honesty and responsibility

* 提供實用安全的電源，做誠信負責的企業

* 実用的、安全な電源を提供し、誠実と信用、責任を持つ企業。

ELECTRICAL PERFORMANCE / 電器性能

1.SAFETY STANDARD / 安規標準

- 1.1 The green mode power supply shall be certified by the following international regulatory standards: 充電器應符合下列的國際標準：

Certificate 證書	Country 國家	Standard/安規標準	Certificate 證書	Country 國家	Standard/安規標準
<input checked="" type="checkbox"/> UL/cUL	USA/CA 北美	UL62368-1; ETL/UL 62368	<input checked="" type="checkbox"/> FCC	USA	47 CFR FCC Part 15, Subpart B ANS I C63.4: 2014
<input checked="" type="checkbox"/> LVD / UKCA	Eu / UK 歐盟 英國	EN62368 BSEN 62368 EN 61558;EN60335	<input checked="" type="checkbox"/> CE	Europe 歐洲	EN55032;EN55035; EN55024;EN61000; EN55022;
<input checked="" type="checkbox"/> CB	Global 全球	IEC62368;IEC61558; IEC60335: IEC60601:	<input checked="" type="checkbox"/> KC	Korea 韓國	K60950-1
<input checked="" type="checkbox"/> PSE	Japan 日本	J62368;J60335	<input checked="" type="checkbox"/> SAA/RCM	AU 澳洲	AS/NZS 62368.1:2018 AS/NZS 60335.2.29
<input checked="" type="checkbox"/> GS	Germany 德國	EN 62368-1	<input type="checkbox"/> CCC	CN 中國	GB 17625.1-2012;GB 4943.1-2011

2.INPUT FEATURE / 輸入特性

- 2.1 INPUT VOLTAGE RANGE: 90Vac to 264Vac. 輸入電壓範圍可以從90Vac到264Vac.
- 2.2 RATED INPUT VOLTAGE: 100Vac to 240Vac. 額定輸入電壓從100Vac到240Vac.
- 2.3 INPUT FREQUENCY RANGE: 47Hz to 63Hz. 輸入頻率範圍從47Hz到63Hz.
- 2.4 INPUT CURRENT: 3.0A max.&100-240Vac. 最大輸入電流3.0A (輸入條件100-240Vac)
- 2.5 INRUSH CURRENT: 60A max. at 100-240Vac input for a cold start at 25°C. 在准開機條件下，最大浪湧電流不超過60A (輸入條件100-240Vac).
- 2.6 EFFICIENCY: higher than 88% at 100-240Vac input and output full load. 效率高於88% (輸入100-240Vac 和輸出滿載條件) .
- 2.7 No-Load Input Power Dissipation/輸入空載功率損耗： Input 115Vac or 230Vac,output no load, the input power loss is less than 0.21W. 輸入115/230V交流，在空載時，輸入功耗

3.OUTPUT/輸出特性

RATED OUTPUT / 額定輸出	SPEC. LIMIT / 規格限定		REMARK / 備註
	Min. value	Max. value	
Output regulation / 輸出電壓規格	22.8VDC	25.2VDC	24V±5%
Output load / 輸出負載規格	0.0A	6.25A	Peak Current:7.5A
Ripple and Noise / 輸出紋波及雜訊	—	<250mVp-p	20MHz Bandwidth 10uF Ele. Cap.& 0.1uF Cer. Cap
Output Overshoot / 輸出過沖幅度	—	10%	
Line regulation / 電壓調整率	—	±1%	
Load regulation / 負載調整率	—	±3%	
Turn-on delay time / 開機延遲時間	—	3000mS	
Hold up time / 關機維持時間	10mS	—	Input voltage:115Vac
	20mS	—	Input voltage:230Vac

EDITION	A	PAGE	3/10
----------------	----------	-------------	-------------

ELECTRICAL PERFORMANCE / 電器性能

4.4 IELECTRIC WITHSTANDING STRENGTH(HI-POT) / 絕緣介電強度 (耐壓)

Primary to Secondary AC3000V, 10mA,1 minute for type test, 3 second for production.
一次側對二次側：AC3000V, 10mA標準測試1分種，量產測試3秒鐘。

5.PROTECTION FEATURE / 保護特性

5.1 OVER—CURRENT PROTECTION / 過電流保護：

The green mode power supply shall be hiccup when any output operating in overload condition(set@ Max load 120~180%) under any line condition for an indefinite period of time. The power supply shall be self — recovery when the fault condition is removed. 在任何時候任何輸入條件，當輸出操作在超載條件最大電源的（120~180%）時，電源供應器將進入打嗝模式，當故障被移走後，電源要能自動恢復到正常。

5.2 SHORT—CIRCUIT PROTECTION / 輸出短路保護：

The power supply shall be hiccup and no damage shall occur when any output operating in a short circuit condition under any line condition for an indefinite period of time. The power supply shall be self—recovery when the fault condition is removed. 在任何時候，任何輸入條件下，當輸出操作在短路情況下，電源供應器將進入打嗝模式，當故障消失後，電源要能自動恢復正常。

6.ENVIRONMENTAL CONDITIONS / 環境條件

6.1 OPERATING / 操作條件：

The power supply shall be capable of operating continuously in any mode without performance deterioration in the following environmental conditions. 在下列環境條件下，電源供應器要能夠連續操作在各種模式，且不能造成性能的退化。

6.1.1 **Operating Temperature: -20°C~40°C 工作溫度：-20°C~40°C**

6.1.2 **Relative Humidity: 10%~90% 相對濕度：10%~90%**

6.1.3 **Vibration: 1.0mm, 10—25Hz, 15 minutes per cycle for each axis (X, Y, Z)**

6.1.4 **Cooling: The power supply will operate with convection cooling. Blocking of vents must not cause damage to the power supply. 電源供應器將操作在對流冷卻的環境下，即使將通風口阻塞電源也不允許有任何損傷發生。**

6.2 NON—OPERATING / 非操作條件：

The power supply shall be capable of withstanding the following environmental conditions extended periods of time, without sustaining electrical or mechanical damage and subsequent operational deficiencies.

電源供應器要能夠長期的經受下列的環境條件，且不允許有電氣級機械方面的損傷和併發的操作的缺失

6.2.1 **Storage Temperature: -30°C~70°C 儲存溫度：-30°C~70°C**

6.2.2 **Relative Humidity: 10%~90%相對濕度：10%~90%**

6.2.3 **Color of case and cable / 外殼及線材顏色：Black / 黑色**

EDITION	A	PAGE	4/10
----------------	----------	-------------	-------------

ELECTRICAL PERFORMANCE / 電器性能

6.2.4 Vibration and Shock / 振動和衝擊

The power supply shall be designed to withstand normal transportation vibration per MIL—STD—810D,method 514 and procedures X, as it s mounted in the chassis assembly and packed for shipping.

電源供應器出貨的包裝設計，均要能承受正常運輸的振動，並符合MIL—STD—810D方法514 和程式 X。

7.EMC STANDARDS / 電磁相容性標準

7.1 EMI STANDARDS / EMI 標準

The power supply met the radiated and conducted emission requirements for FCC CLASS B, EN55032 CLASS B.

本電源供應器符合輻射及傳導要求，滿足FCC CLASS B, EN55032 CLASS B.

7.2 EMS STANDARDS / EMS 標準

The power supply shall meet the following EMS standards: 本電源供應器滿足下列EMS標

7.2.1 EN61000-4-2: 2009 / A1: 1998 Electrostatic Discharge(ESD)

7.2.2 EN61000-4-3: 2010 / A1: 1998 Radiated Electromagnetic Fields(RS)

7.2.3 EN61000-4-4: 2012 Electrical Fast Transient / Burst(EFT)

7.2.4 EN61000-4-5: 2014 Lighting Surge Attachment. Line to Neutral: 2KV

8 RELIABILITY AND QUALITY CONTROL / 可靠性及品質控制

8.1 BURN—IN / 老化

The power supply shall undergo a minimum of 4 hours Burn—In test under full load at 40°C~±5°C

電源應在40°C~±5°C和滿載條件下老化4小時。

8.2 COMPONENT DERATING / 元件溫度要求

Semiconductor junction temperatures shall not exceed the manufacturer's maximum thermal rating. 半導體結溫不允許超過其製造商要求的最大溫度值。

9.WEIGHT / 重量

The weight of the power supply shall be about 800g 電源的重量大約為800g。

10.MECHANICAL REQUIREMENT / 結構參數

The power supply size: L176*W80*H47mm.外殼尺寸: L176*W80*H47mm

11.INSULATION RESISTANCE / 絕緣阻抗

Input to output: 50M OHM(500VDC)輸入對輸出50兆歐姆 (500VDC)

EDITION	A	PAGE	5/10
---------	---	------	------

ELECTRICAL PERFORMANCE / 電器性能

12.LEAKAGE CURRENT / 漏電流

The leakage current shall be **less than 0.25mA for class II** when power supply is operated maximum input voltage and maximum load. 當電源供應器操作在最大輸入及最大負載情況下，其漏電流應**小於0.25mA, 滿足class II等級**。

13.MAJOR MEASURE EQUIPMENT / 主要測量設備; VERIFIED BY THE THIRD LAB/外校

- A AC SOURCE / AC變頻電源: 固緯/GWINSTEK APS-7100E,校準頻次: 1次/年 ✓
- B DIGITAL POWER METER / 數字功率計功率儀: 固緯/GWINSTEK GPM-8213,校準頻次: 1次/年 ✓
- C ELECTRONIC LOAD / 開編程電子負載儀: 美爾諾/MAYNUO M9713,校準頻次: 1次/年 ✓
- D OSCILLOSCOPE / 存儲示波器: 泰科/TEKTRONIX TBS1102B,校準頻次: 1次/年 ✓
- E DIGITAL MULTIMETER / 數字式萬用表: 福祿克(FLUKE) F12E+校準頻次: 1次/年 ✓
- F DC POWER / 直流電源: 麥創 (MATRIX) MPS-6030D校準頻次: 1次/年 ✓
- G HIPOT AND INSULATION RESISTANCE TESTER / 耐壓安規測試儀: ✓
固緯/GWINSTEK GPT-9803 ,校準頻次: 1次/年
- H NSULATION RASISTANCE TESTER / 絕緣電阻表: YD2681A,校準頻次: 1次/年 ✓
- I MULTI CHANNEL TEMPERATURE SENSOR / 多路溫度測試儀 ✓
艾維泰科/IVYTECH IV380-16校準頻次: 1次/年

EDITION	A	PAGE	6/10
---------	---	------	------

DC CORD / 輸出線材

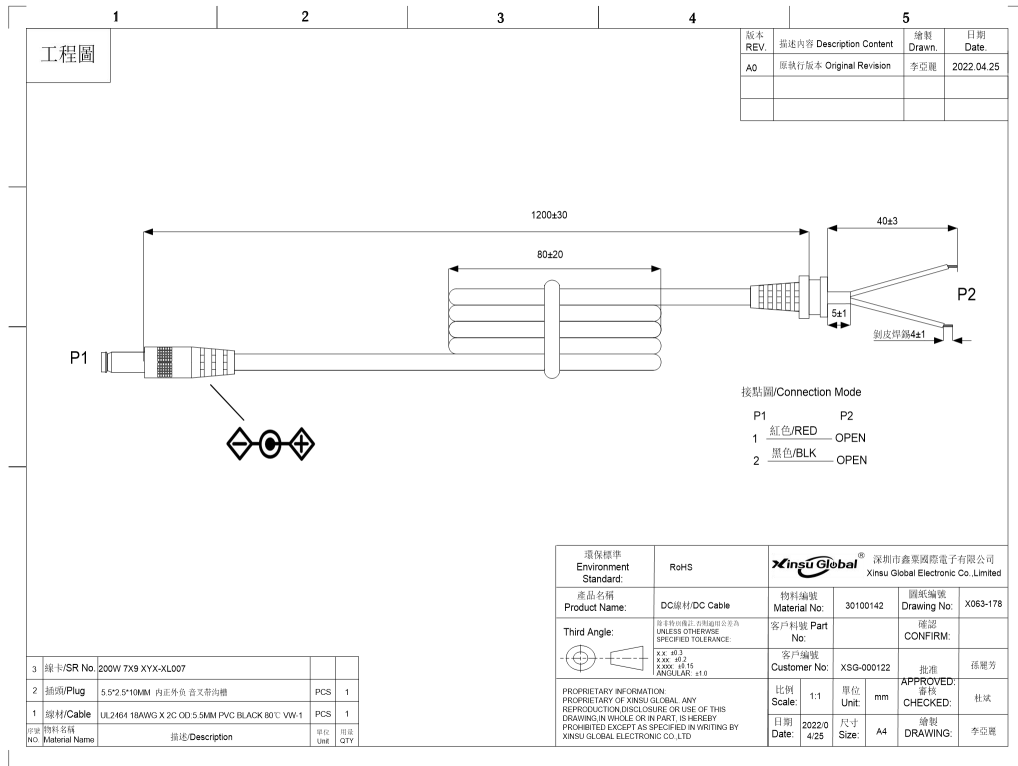

Cable Specification/線材規格		
UL2464 Round Wire, 18AWG*2C L=1.2M Black 80°C,300V		
Item No	Part Name (部件名稱)	Description (描述)
A	Length of DC cord(DC線長度)	1.2M
B	Size of DC connector (DC頭尺寸)	5.5*2.5*10mm直頭內正外負，音叉帶溝槽。
C	Length of coil (線包長度)	70MM±10
D	SR NO(線卡編號)	XYX-XL005
E	Length of inlet wire (出線長度)	30MM±1
F	Tinned length (吃錫長度)	4MM±1

EDITION	A	PAGE	7/10
---------	---	------	------

AC CORD/输入线材

Version: 版本: A	Customer: 鑫聚	Customer P/N: X16001	Customer: 鑫聚
Drawing NO: 图号	X16001	Customer P/N: ACH电源线	Customer: 鑫聚

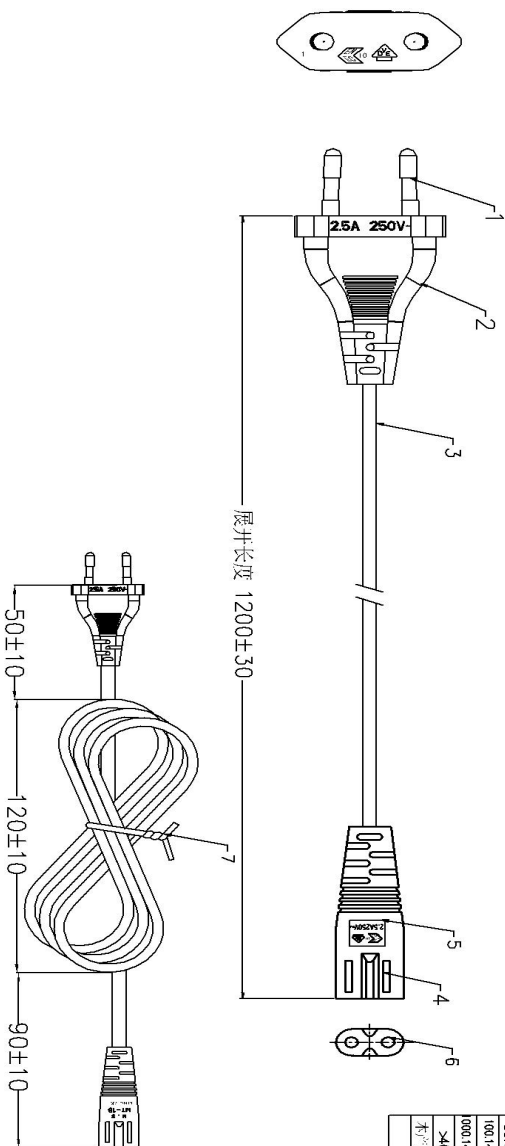

本图适用加工公差表	尺寸范围	公差尺寸
1~6	±1	
6.1~10	±2	
10.1~20	±3	
20.1~50	±4	
50.1~100	±8	
100.1~1000	±15	
1000.1~10000	±40	
>1000	±100	
本产品的材料环保要求	REACH	

线材 印字	KEMA-KEUR VDE REC 60227-5 300/300V H03VH2-F 2X0.75mm ² CABO FLEXIVEL PLANO IEMMEQU +++++ N14440 NEW SQUARE	油印	电印
7 (Wire & cable)	黑色	包PVC绝缘线	1 140
6 (Terminal of end plug)	φ2.35 葫芦铜管		2 磷铜色
5 (Type of end plug)	MT-18<2.5A 250V>ENEC>	BK001 89A PVC	1 黑色
4 (End of cable)	八字起尾套	黑色	1
3 (Cord specification)	VDE H03VH2-F 2X0.75mmSQ	BK001 89A PVC	1 1185-28 黑色
2 (Type of plug)	MT-11<2.5A 250V>ENEC>	BK001 89A PVC	1 黑色
1 (Pin of plug)	欧式固定套	黑色	1 磷铜
ITEM	NAME 名称	SPECIFICATION 型号 / 规格	COLOR 颜色

标题	更改内容	工程
赣州永德电业制品有限公司 TITLE: 名称 PLUG & WIRE Draw: ZHAN Audit: 审核 Date: 日期 Approve: 批准		
2015-10-06		

PRODUCT OUTLINE DIMENSION / 產品外觀尺寸

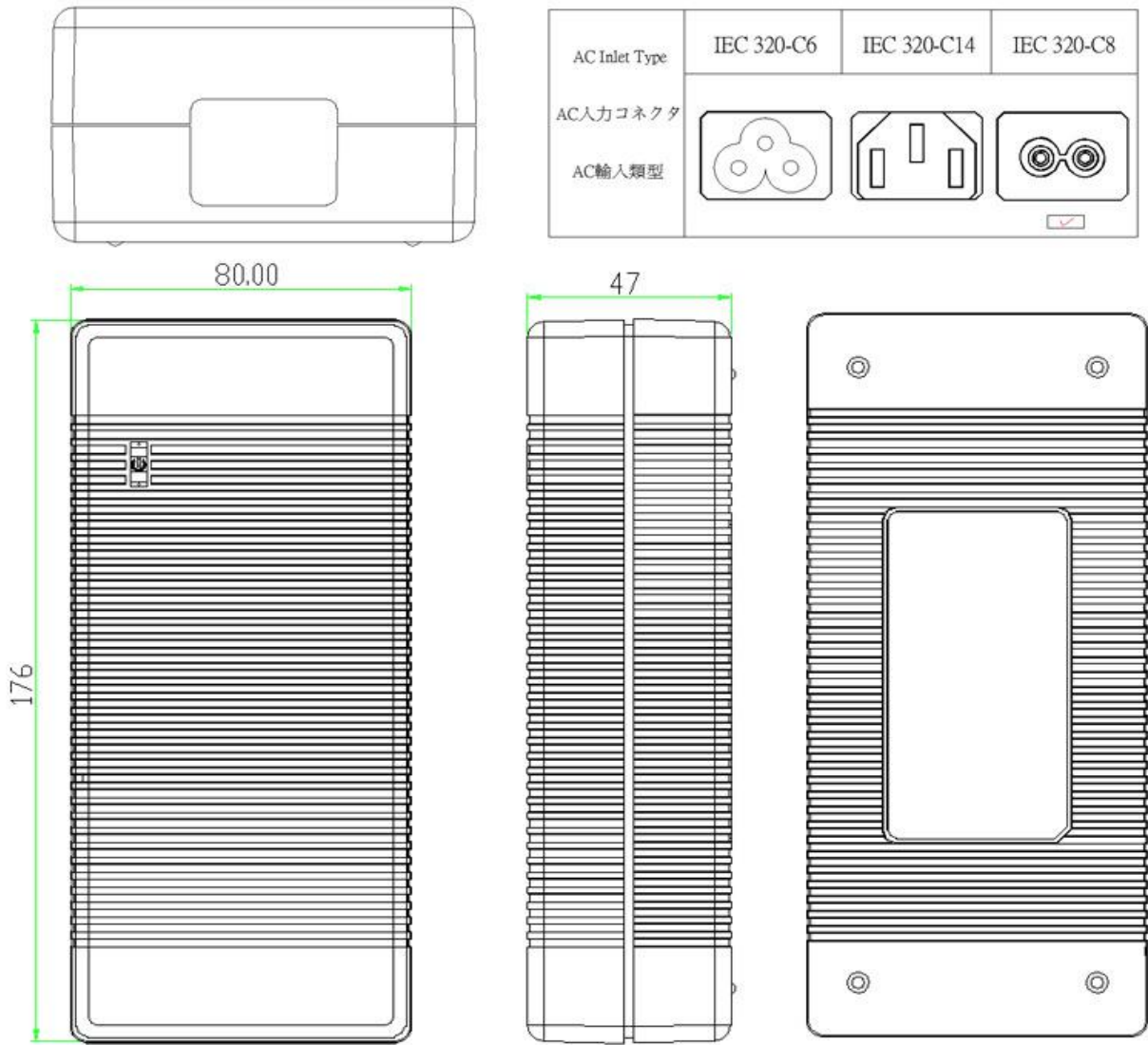

Material/材料: PC

Brand/品牌: SABIC / 沙伯

Fireproof Class/防火等級: UL94V-0

Color/顏色: Black/黑色



EDITION	A	PAGE	9/10
----------------	----------	-------------	-------------



RATING LABEL / 銘牌



Xinsu Global®

SWITCHING POWER SUPPLY
(スイッチング電源)

MODEL(品番): XSG2406250
 INPUT(入力): 100-240V~50/ 60Hz 3.0A
 OUTPUT(出力): 24.0V \equiv 6.25A 150.0W 



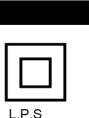

Xinsu Global 株式会社



직류전원장치
 부품명: XSG2406250
 정격입력: 100-240 V~, 50/60 Hz, 3.0A
 정격출력: 24.0V \equiv 6.25A 150.0W
 HU10934-18002B A/S: 02-926-9084

ROHS 
CAUTION: EFFICIENCY
RISK OF ELECTRIC SHOCK
DRY LOCATION USE ONLY
 乾燥している場所でのみ使用してください
 MADE IN CHINA DATE CODE: XXXXXX
 XINSU GLOBAL ELECTRONIC CO., LIMITED

标贴仅供参考

Print/印刷

Laser Carving/鐳雕

1. Silver text on black background 黑底銀字
2. Material: PET 底材為消銀龍.
3. Clear Printing, Wipe Resistance 絲印清晰，耐擦拭.
4. Gum Permanent 永久背膠.
5. Meet Requirements of Environmental Protection 符合環保要求

EDITION	A	PAGE	10/10
----------------	----------	-------------	--------------